

PULSARS



Users Manual

PMV 5250

**DOUBLE OPTION
DC VENDING**

E-mail: info@pulsars.com
www.pulsars.com

PMV 5250 DC Vending

Double Selection

Front Side of the Control Key Board

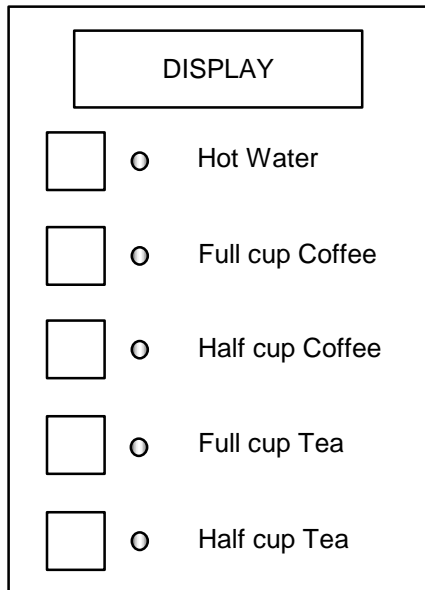

Back Side of the Control Key Board

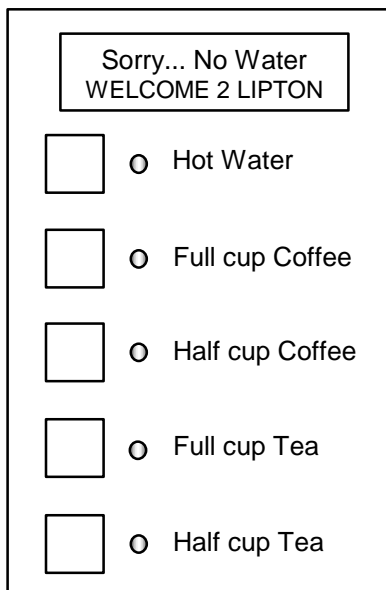
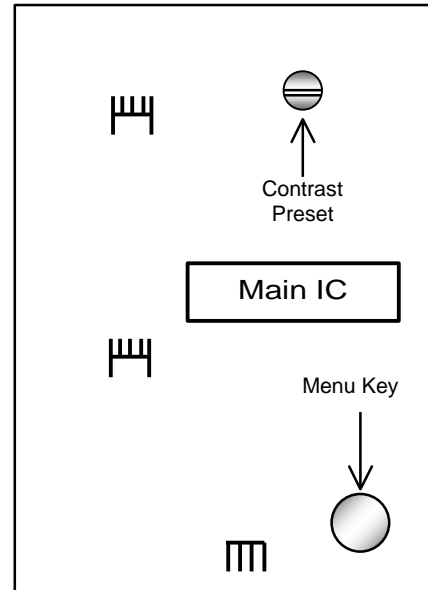

- Fill the water in main tank, it is unable to dispense.

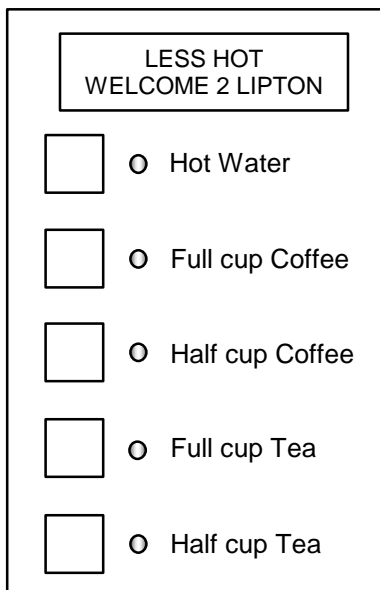

- Wait few minutes to take drink.
- It is unable to dispense immediately.

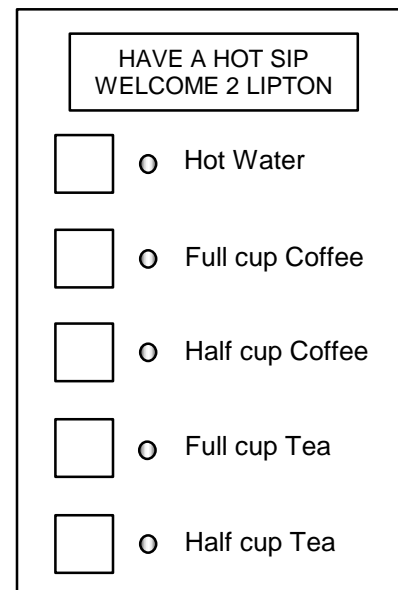

- Ready mode.
- It is ready to dispense.

OPERATIONS

- To dispense coffee:

FULL CUP COFFEE
WELCOME 2 LIPTON

○ Hot Water

● Full cup Coffee

○ Half cup Coffee

○ Full cup Tea

○ Half cup Tea

Select Your Drink 'Full cup Coffee'

HALF CUP COFFEE
WELCOME 2 LIPTON

○ Hot Water

○ Full cup Coffee

● Half cup Coffee

○ Full cup Tea

○ Half cup Tea

Select Your Drink 'Half Cup Coffee'.

- ◆ *Similar operations for dispense Tea.*

- To dispense hot water in Coffee side:

HAVE A HOT SIP
WELCOME 2 LIPTON

● Hot Water

○ Full cup Coffee

○ Half cup Coffee

○ Full cup Tea

○ Half cup Tea

Press 'Hot Water' key 1-2 seconds till display shows 'Flushing C/T'.

FLUSHING C/T
WELCOME 2 LIPTON

○ Hot Water

● Full cup Coffee

○ Half cup Coffee

○ Full cup Tea

○ Half cup Tea

Press 'Coffee' to take hot water in Coffee side

- ◆ *Similarly for dispensing of hot water in Tea side.*

- To display the 'Counts' and 'Temperature':

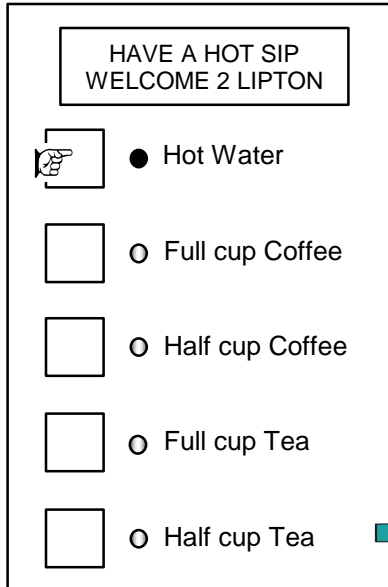

Press hot water key for 1 - 2 seconds till display shows 'FLUSHING C/T'.

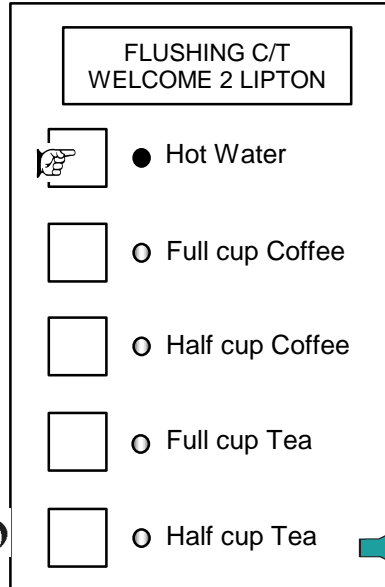

Again press Hot water key (Beep) display shows 'Counts display'.

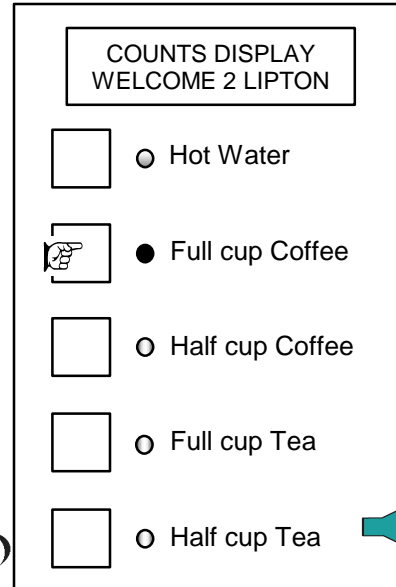

Press 'Full cup Coffee' key (Beep)

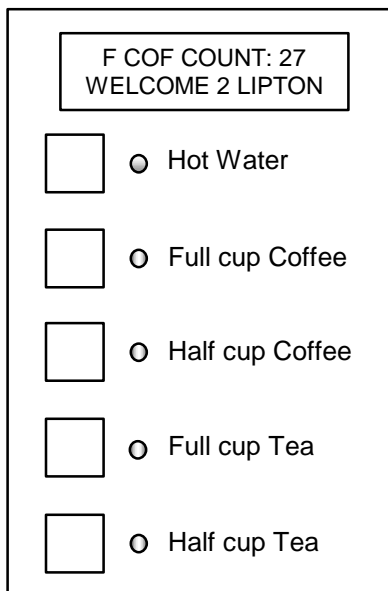

It shows the full cup coffee's count.

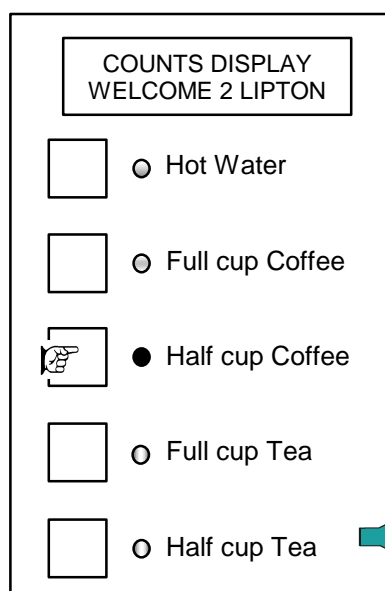

Press 'Half cup Coffee' key (Beep)

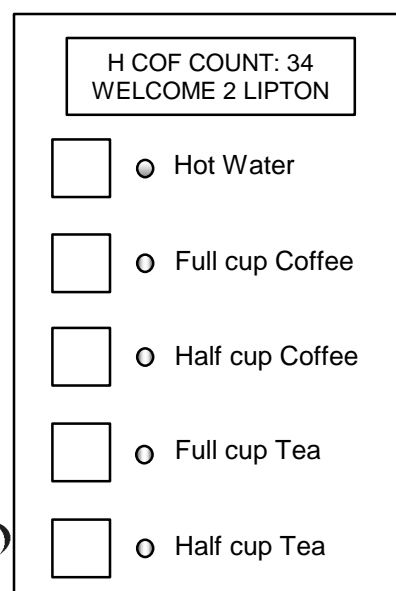

It shows the Half-cup coffee's count.

◆ *Similarly for Tea.*

Tips: When you finished your counts, the display automatically returns to dispense mode in 10 seconds.

▪ To display the Temperature.

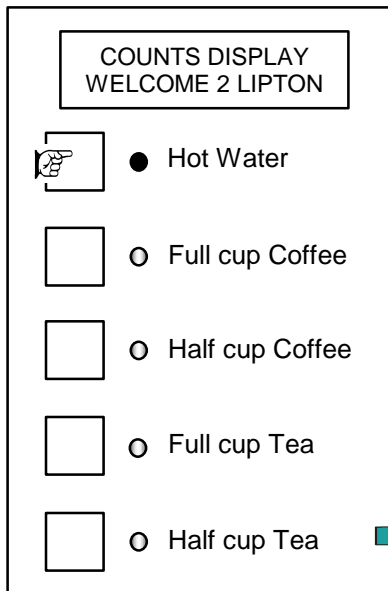

Go to 'counts mode' and press 'Hot water' key again.

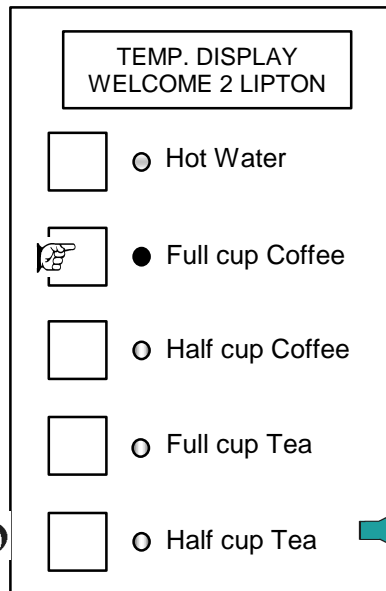

Then press 'Full cup Coffee' key.

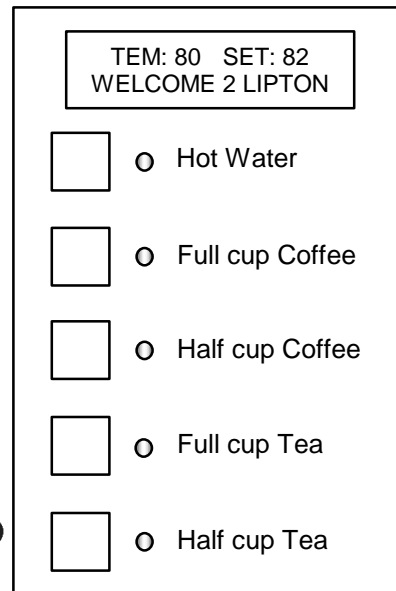

It shows the current temperature.

▪ To manually fill the Boiler:

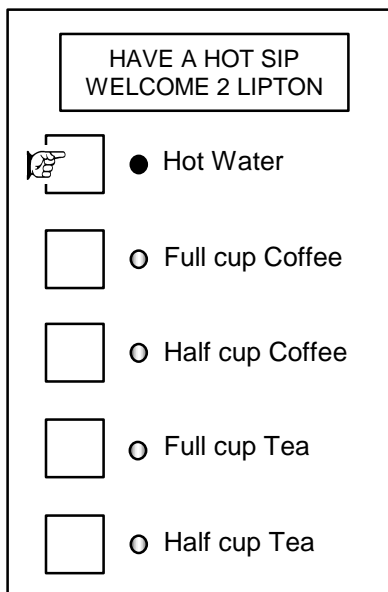

Continually press 'Hot water' key, till boiler is filled.

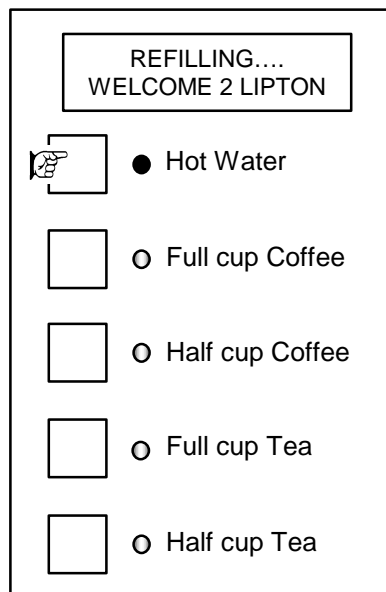

When you release the key, the manual refilling is stopped.

▪ Programming the Control Card:

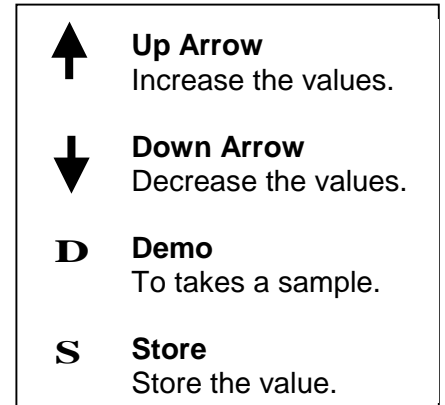
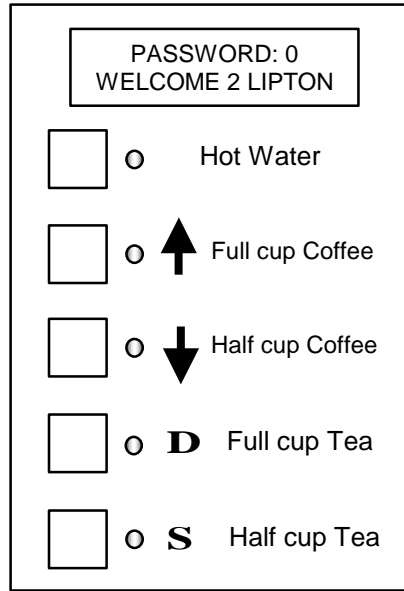
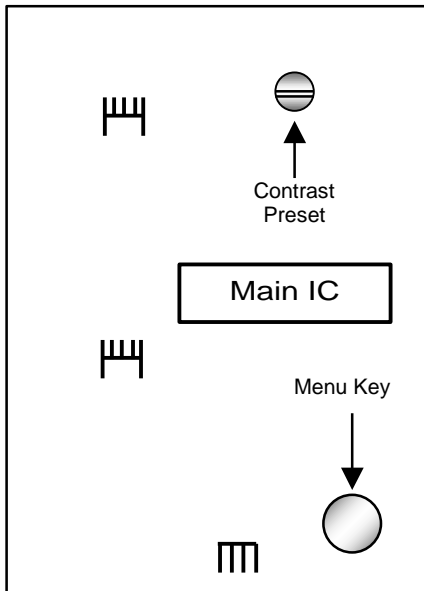

Tips: These four keys function differently in this mode.

Press menu key once.

- Factory set of Password value = 0
- Use Up / Down arrow key to bring your password on the screen.
- Then press Store key to enter the 'Settings mode'.

HOW TO SET ALL PROGRAMS?

- First go to the settings mode.

Tips:

Powder time should be < water time by atleast 1 second.

A) Coffee Water.

B) Coffee Powder.

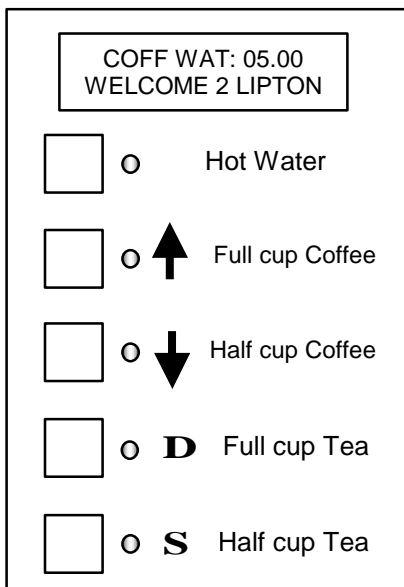

Water Set for Coffee:

It shows 'Coff Wat' on display, then set the value by using Up / Down arrow keys. And press 'store' key to accept.

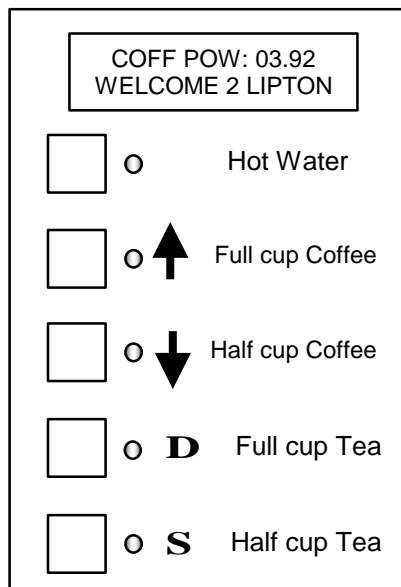

Powder Set for Coffee:

It shows 'Coff Pow' on display, then set the value by using Up / Down arrow keys. And press 'store' key to accept.

◆ *Similarly for other drinks*

C) Tea Bag Mode.

TEA BAG MODE: N
WELCOME 2 LIPTON

<input type="checkbox"/>	○		Hot Water
<input type="checkbox"/>	○	↑	Full cup Coffee
<input type="checkbox"/>	○	↓	Half cup Coffee
<input type="checkbox"/>	○	D	Full cup Tea
<input type="checkbox"/>	○	S	Half cup Tea

Tea Bag mode:

It shows 'Tea Bag mode Y/N: N' on display, then set the value by using 'Demo' key. And press 'store' key to accept.

D) Temperature set.

SET TEMP – 82
WELCOME 2 LIPTON

<input type="checkbox"/>	○		Hot Water
<input type="checkbox"/>	○	↑	Full cup Coffee
<input type="checkbox"/>	○	↓	Half cup Coffee
<input type="checkbox"/>	○	D	Full cup Tea
<input type="checkbox"/>	○	S	Half cup Tea

Temp. Set:

It shows 'SET TEMP' on display, then set the value by using Up / Down arrow keys. And press 'store' key to accept.
Min: 72
Max: 95

E) Coin mech. Set.

COIN MECH Y/N: N
WELCOME 2 LIPTON

<input type="checkbox"/>	○		Hot Water
<input type="checkbox"/>	○	↑	Full cup Coffee
<input type="checkbox"/>	○	↓	Half cup Coffee
<input type="checkbox"/>	○	D	Full cup Tea
<input type="checkbox"/>	○	S	Half cup Tea

Coin mech:

It shows 'Coin mech Y/N: N' on display, then set the value by using 'Demo' key. And press 'store' key to accept.

F) Initial boiler fill.

INT.B.FIL Y/N: N
WELCOME 2 LIPTON

<input type="checkbox"/>	○		Hot Water
<input type="checkbox"/>	○	↑	Full cup Coffee
<input type="checkbox"/>	○	↓	Half cup Coffee
<input type="checkbox"/>	○	D	Full cup Tea
<input type="checkbox"/>	○	S	Half cup Tea

Initial boiler fill:

It shows 'INT.B.FIL Y/N: N' on display, then set the value by using 'Demo' key. And press 'store' key to accept.

G) Auto clean.

Auto Clean Y/N: N
 WELCOME 2 LIPTON

<input type="checkbox"/>	○		Hot Water
<input type="checkbox"/>	○	▲	Full cup Coffee
<input type="checkbox"/>	○	▼	Half cup Coffee
<input type="checkbox"/>	○	D	Full cup Tea
<input type="checkbox"/>	○	S	Half cup Tea

Auto clean:

It shows 'Auto clean Y/N: N' on display, then set the value by using 'Demo' key. And press 'store' key to accept.

H) Half cup enabled.

HALF CUP ENABLE-Y
 WELCOME 2 LIPTON

<input type="checkbox"/>	○		Hot Water
<input type="checkbox"/>	○	▲	Full cup Coffee
<input type="checkbox"/>	○	▼	Half cup Coffee
<input type="checkbox"/>	○	D	Full cup Tea
<input type="checkbox"/>	○	S	Half cup Tea

Half cup enable:

It shows 'Half cup enable Y/N: N' on display, then set the value by using 'Demo' key. And press 'store' key to accept.

I) Change Password.

COIN MECH Y/N: N
 WELCOME 2 LIPTON

<input type="checkbox"/>	○		Hot Water
<input type="checkbox"/>	○	▲	Full cup Coffee
<input type="checkbox"/>	○	▼	Half cup Coffee
<input type="checkbox"/>	○	D	Full cup Tea
<input type="checkbox"/>	○	S	Half cup Tea

Password Set:

It shows 'Change Password' on display, then set the value by using Up / Down arrow keys. And press 'store' key to accept.

**Min: 0
Max: 9999**

J) Exit from the program.

EXIT
 WELCOME 2 LIPTON

<input type="checkbox"/>	○		Hot Water
<input type="checkbox"/>	○	▲	Full cup Coffee
<input type="checkbox"/>	○	▼	Half cup Coffee
<input type="checkbox"/>	○	D	Full cup Tea
<input type="checkbox"/>	○	S	Half cup Tea

Ending program